

Square Cartons

# Model ELVS

Recommended Corrugated Specifications  
for BestPack Case Erectors



**01**  
Slots must extend  
1/8" below score line.

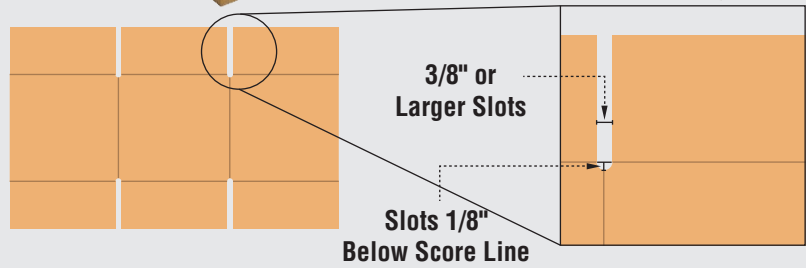

**02**  
The Flap Length is to be Made  
Shy Cut or Scant Cut so that  
when the Side Panel Flaps are  
Folded Closed there is a 1/8"  
Space Between them.

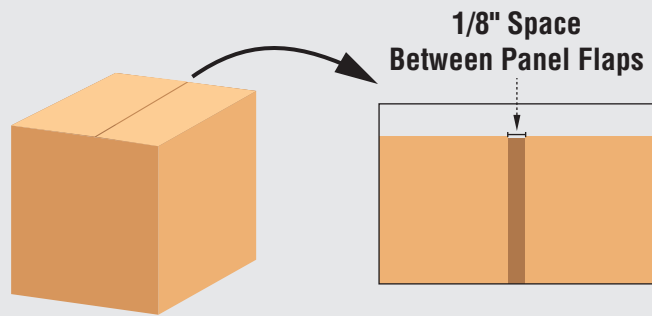

**03**  
If case is square, it will be necessary to  
have an additional slot placed in the  
facing end flaps (both top and bottom)  
but not in the rear side flap. The opening  
mechanism on the vertical case former  
requires these slots only if the case  
is square.

**Square Cartons**

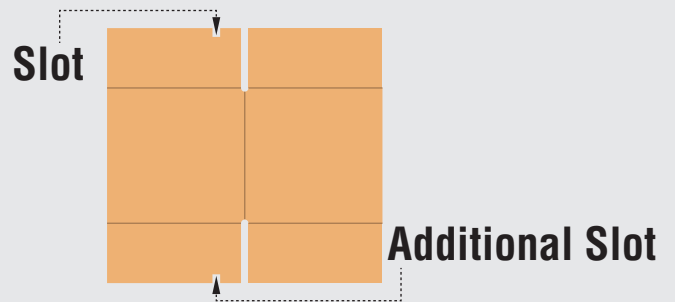

**04**  
Scoring should be male  
to female with female  
on the interior surface.

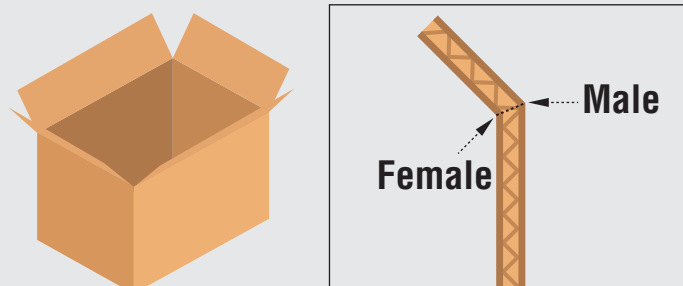

# Left Justified ELVS

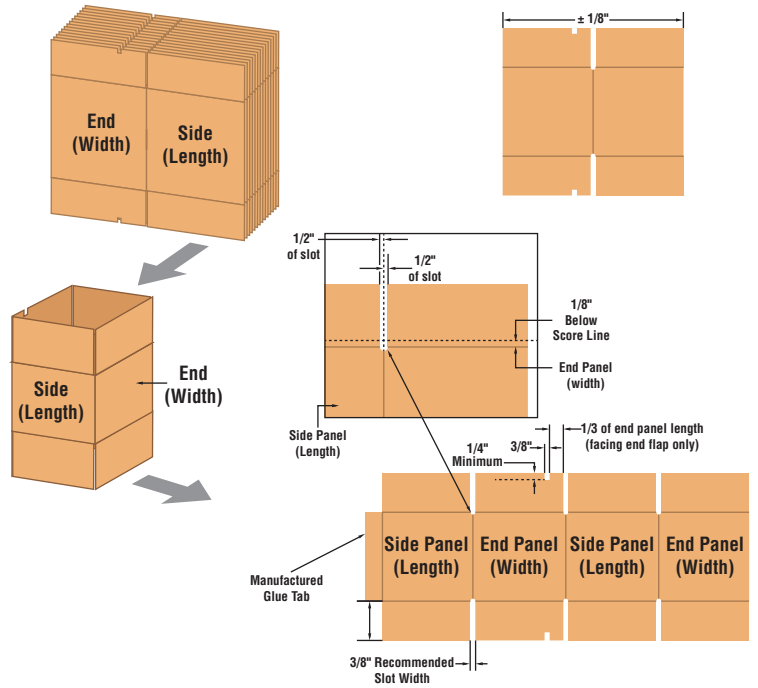
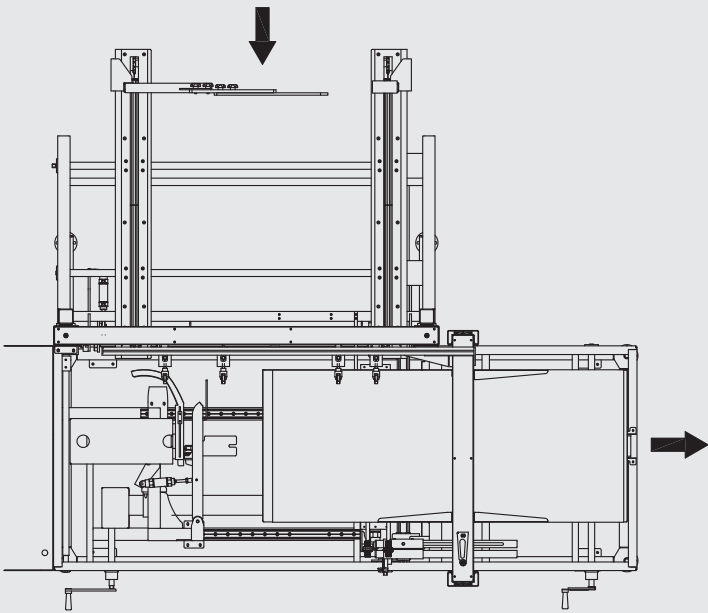

# Right Justified ELVS

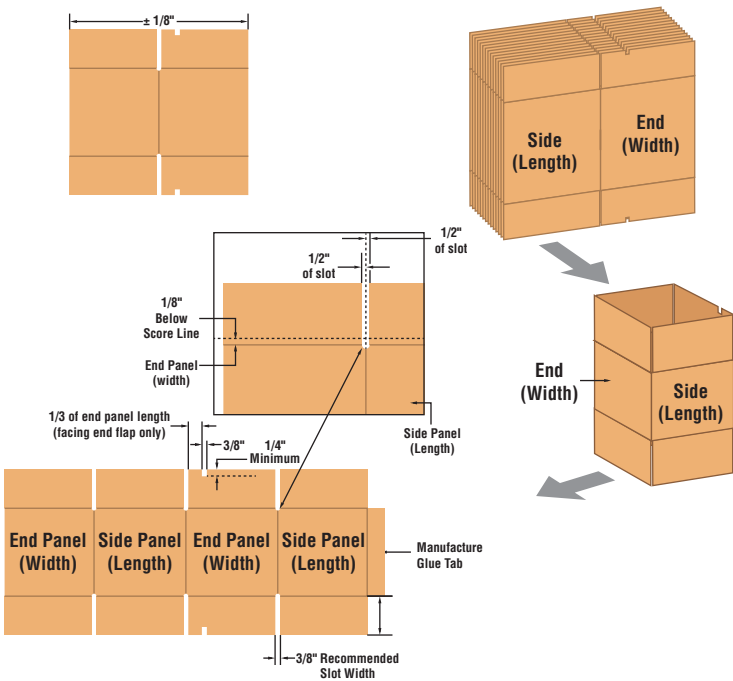

(Corrugated Outside View)

