



BESTPACK

Square Cartons

Model ELVS

Recommended Corrugated Specifications
for BestPack Case Erectors

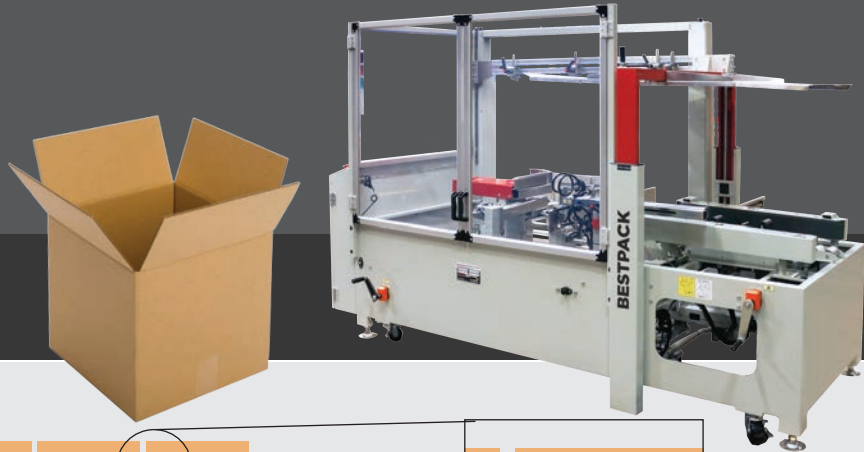

01
Slots must extend
1/8" below score line.

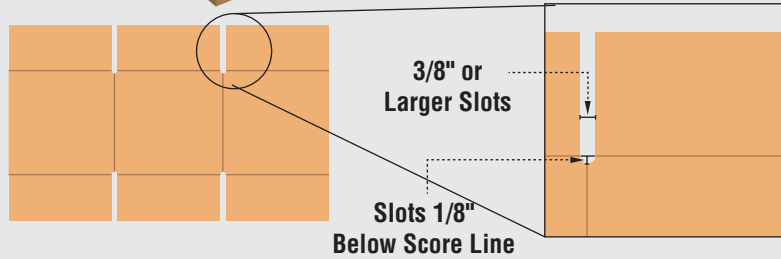

02
The Flap Length is to be Made
Shy Cut or Scant Cut so that
when the Side Panel Flaps are
Folded Closed there is a 1/8"
Space Between them.

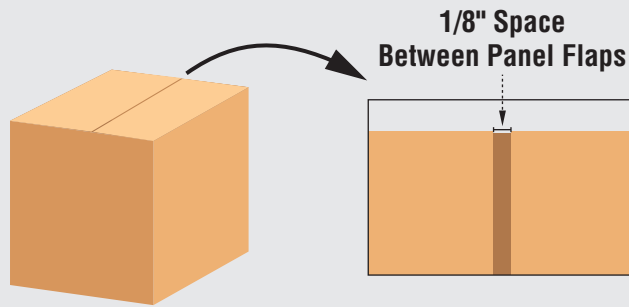

03
If case is square, it will be necessary to
have an additional slot placed in the
facing end flaps (both top and bottom)
but not in the rear side flap. The opening
mechanism on the vertical case former
requires these slots only if the case
is square.

Square Cartons

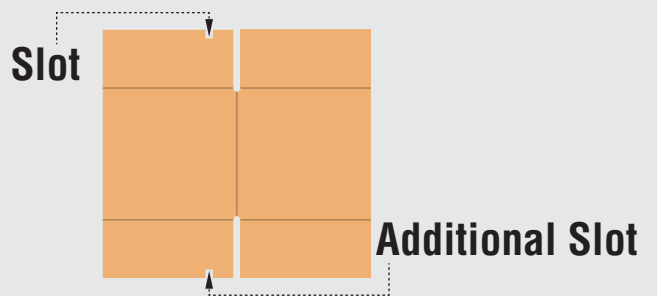

04
Scoring should be male
to female with female
on the interior surface.

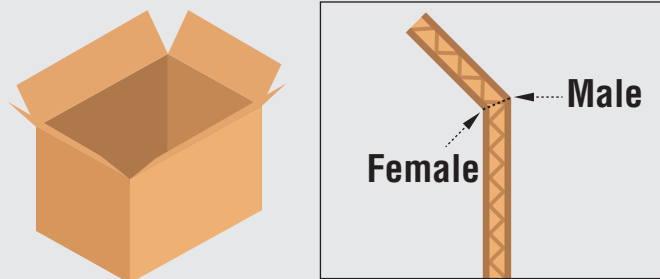

Left Justified ELVS

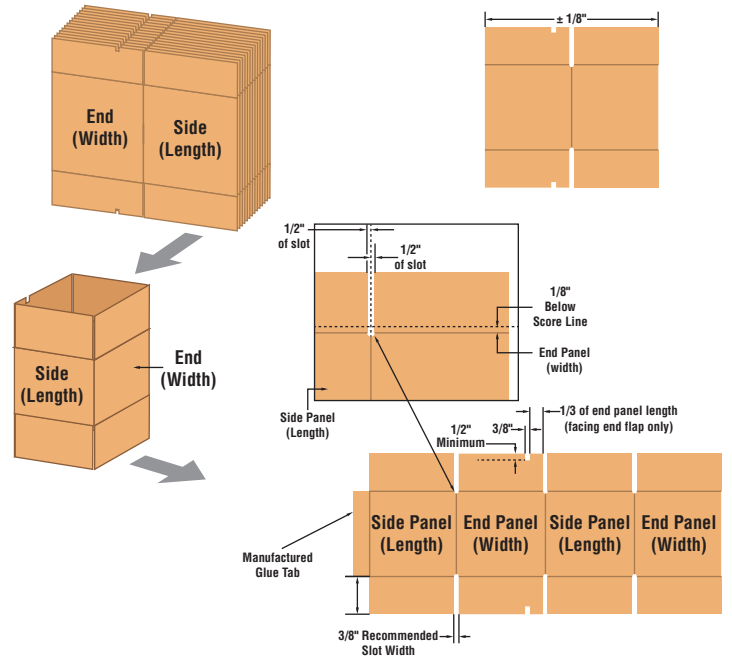
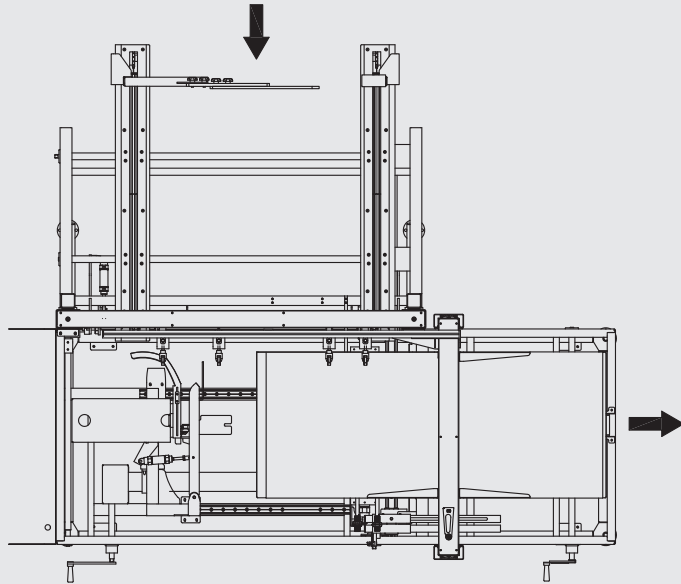

Right Justified ELVS

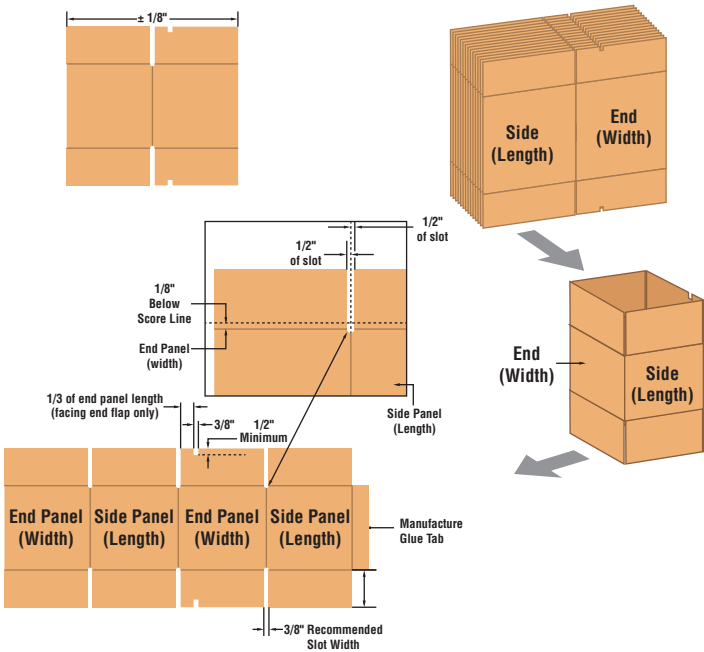

(Corrugated Outside View)

